



# 2 FOOT LINEAR SERIES

## DESCRIPTION

Designed to outshine and outlast the competition, this linear luminaire fixture features advanced electronic technology like Pulse Width Modulation, Electronic Thermal Management, and a Failsafe Redundant Circuit Design that allow the fixture to function even if half of the light should fail in extreme conditions.

### Features and Benefits:

- Fluorescent Tube Replacement
- Built-in Battery Backup System Available
- Die-Cast 6061 Aluminum Housing
- UL and DLC Certified, IP-67 Rated for Damp Locations

## SPECIFICATIONS

### MECHANICAL:

<b>Fixture Weight:</b>	6.8 lbs (3.08kg)
<b>Shipping Weight:</b>	8.13 lbs (3.69kg)
<b>Mounting:</b>	3/4" NPT Quick Connect

### TECHNICAL:

<b>LED:</b>	MHB-B(CREE)
<b>Lumens:</b>	7,800 lm
<b>Beam Pattern:</b>	180°
<b>Wattage:</b>	60W
<b>Amp Draw:</b>	0.5A @ 120VAC 0.27A @ 220VAC
<b>Color Temperature:</b>	5000 Kelvin
<b>Operating Voltage:</b>	90 - 305VAC   127 - 300VDC
<b>Operating Temp:</b>	-40°C ~ 40°C
<b>Lifespan:</b>	50,000 hrs
<b>Frequency:</b>	47-63Hz
<b>THD:</b>	< 20% (@load≥75% /100-277VAC)
<b>Power Factor:</b>	≥ 0.98/120VAC ≥ 0.96/220VAC
<b>Short Circuit:</b>	Constant Current Limiting, Recovers Automatically After Fault Condition is Removed
<b>Polarity:</b>	Reverse Polarity Protection

### CONSTRUCTION:

<b>Housing:</b>	Die-Cast 6061 Aluminum
<b>Finish:</b>	Gloss Grey
<b>Lens:</b>	Polycarbonate Lens



### PART #:

### BEAM PATTERN

<b>LLG0221180F</b>		180° Ultra Wide Flood
<b>LLG0221180FSRQC</b>	Stainless Steel w/ Quick Connect	180° Ultra Wide Flood
<b>LBG0221180F</b>	Built-in Battery Backup	180° Ultra Wide Flood
<b>LAYUC2M</b>	6' 6" Quick Connect Cable	-

### 2D DRAWING:

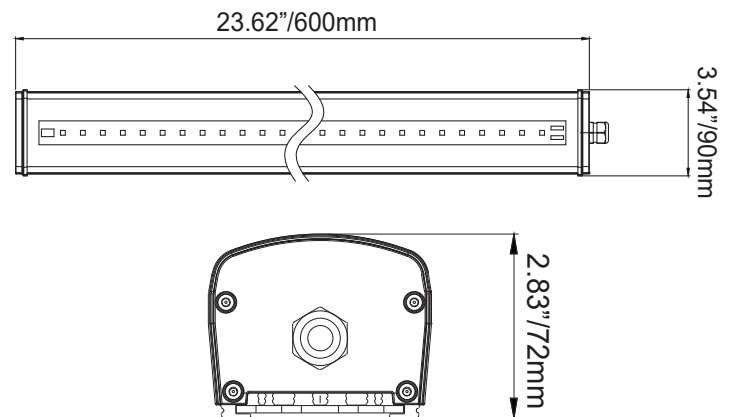

### RATINGS:

<b>EMC Emission:</b>	Compliance to EN55022, EN61000-3-2 Class A, EN61000-3-3
<b>EMC Immunity:</b>	Compliance to EN55024, EN61000-4-2,3,4,5,6,8,11; light industry level (surge 2KV), criteria A
<b>Ingress Protection:</b>	IP-67 Rated for Damp Locations
<b>Vibration Rating:</b>	8.7 Grms
<b>Warranty:</b>	5 Years